

KENWOOD

KCA-R10

CONTROLLER FOR CD-AUTOCHANGER
INSTRUCTION MANUAL

COMMANDE POUR CD-CHANGEUR
MODE D'EMPLOI

BEDIENUNGSEINHEIT FÜR CD-WECHSLER
BEDIENUNGSANLEITUNG

KONTROLEEENHEID VOOR CD-WISSELAAR
GEBRUIKSAANWIJZING

COMANDO PER MULTILETTORE CD
ISTRUZIONI PER L'USO

KENWOOD CORPORATION



Take the time to read through this instruction manual. Familiarity with installation and operation procedures will help you obtain the best performance from your new controller for CD-autochanger.

For your records

Record the serial number, found on the back of the unit, in the spaces designated on the warranty card, and in the space provided below. Refer to the model and serial numbers whenever you call upon your KENWOOD dealer for information or service on the product.

Model KCA-R10 Serial number _____

⚠ WARNING

TO PREVENT ELECTRIC SHOCK,
FIRE AND OTHER INJURY.
PLEASE NOTE THE FOLLOW-
INGS:

- The unit is designed to be connected 12 V DC and negative grounding.
- Do not place the unit, where it will be exposed to direct sunlight or close to heating device.

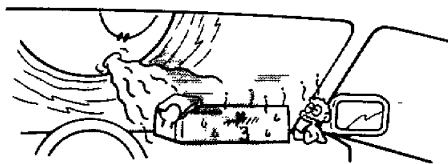
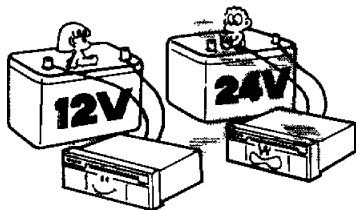

- Do not open enclosure, such as front panel, top or bottom cover.
- Do not dash water on the unit.

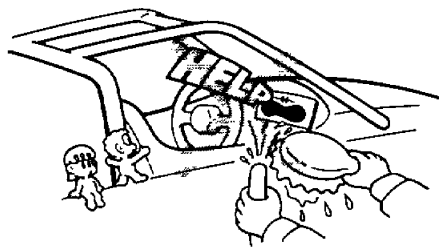
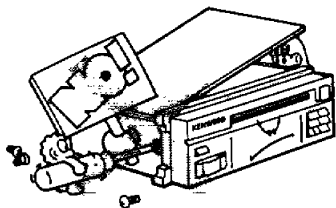

- Do not drop pieces of metal, needles, coins and other electrically conductive materials into the unit.
- Do not place the unit in areas of excessive dust, high humidity or on unstable surfaces.

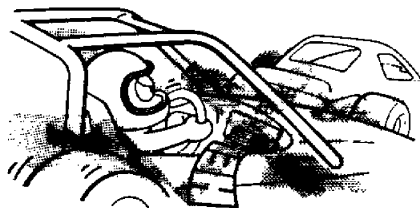
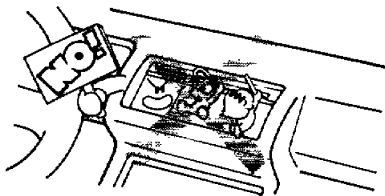

CLEANING

1. Turn the power off, before cleaning the unit.
2. Do not use any type of abrasive pad, thinner, benzene and any such kind of objects.
3. Wipe the front panel and other exterior surfaces of the unit with a soft dry cloth or a soft cloth lightly moistened with a neutral detergent.

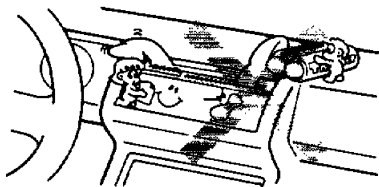

- If an abnormal smell or smoke is detected, immediately turn the power off.



- If you have difficulty in installing the set in your car, please contact your KENWOOD dealer.

FCC WARNING:

This equipment may generate or use radio frequency energy. Changes or modifications to this equipment may cause harmful interference unless the modifications are expressly approved in the instruction manual. The user could lose the authority to operate this equipment if an unauthorized change or modification is made.

- If your set malfunctions or operates abnormally, first press the Reset button. If the malfunction persists, leave the set as it is and please call your KENWOOD dealer.

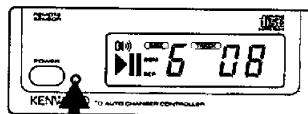

Reset button

CONTENTS

	Page
• COMPACT DISC PLAY	5
• DISC/TRACK SEARCH	6
• TRACK REPEAT	7
• TRACK SCAN	8
• RANDOM PLAY	9
• RETURN	10
• ACCESSORIES AND INSTALLATION	11
• CONNECTION	12
• INSTALLATION	13
• TROUBLESHOOTING GUIDE	15
• SPECIFICATIONS	17

COMPACT DISC PLAY

COMPACT DISC PLAY

Press the Power switch.
(The power goes ON and the CD play start.)

The light turns on for an instant every time the controller switch is pressed.

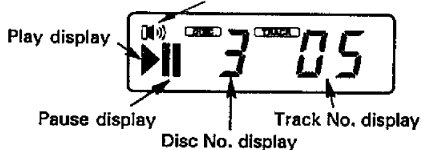

CONTROLLER POWER

Controller is turned ON/OFF as the Power switch is pressed.
(Indication on display unit goes off when power is turned OFF, then output is gradually cut as power is being turned ON.)

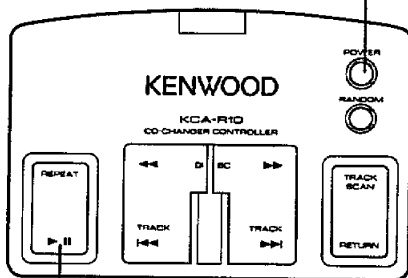
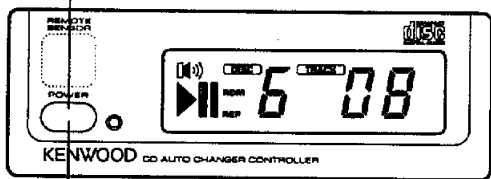

POWER OFF

Press the Power switch.
(The power goes OFF.)

PAUSE

Press the Play/Pause switch.
(Disc play is temporarily paused.)
If you press the switch once more, the disc is replayed from the paused part.



At the end of the disc

- When disc reaches the end of the last selection of the next disc starts automatically. At the end of the last disc, the unit will go back to the beginning of the first disc, and the play will restart.

DISC/TRACK SEARCH

BACKWARD DISC SEARCH

Press the DISC ◀ switch successively until the Disc No. display shows the desired disc No.



Disc No. display

FORWARD DISC SEARCH

Press the DISC ▶ switch successively until the Disc No. display shows the desired disc No.



Disc No. display

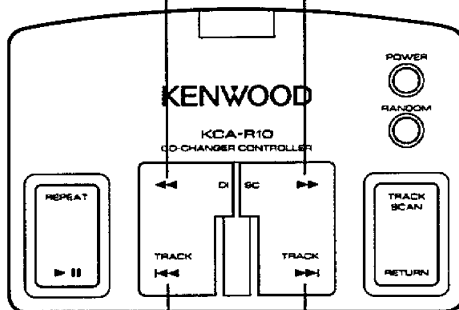

BACKWARD TRACK SEARCH

Press the TRACK ◀ switch successively until the Track No. display shows the desired track No.
If the TRACK ◀ switch is pressed once while each track is displayed for more than four seconds, it returns to the beginning of the track.



Track No. display

FORWARD TRACK SEARCH

Press the TRACK ▶ switch successively until the Track No. display shows the desired track No.

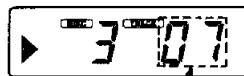

Track No. display



- If Backward track search is initiated while track No. 1 is being played, the play position always returns to the beginning of track No. 1 and other tracks cannot be searched.
- If Forward track search is initiated while the last track of a disc is being played, no operation takes place.
- The Disc No. display of No. 10 Disc is "0".

TRACK REPEAT

1

Press the Track repeat switch.



2

The track being played is played repeatedly.

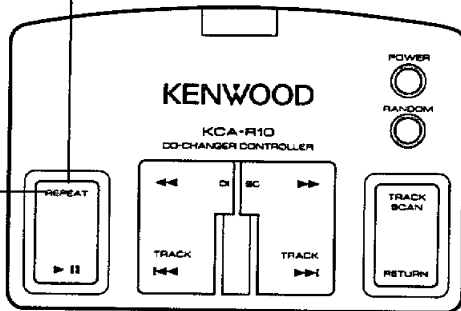

TO RELEASE

Press the Track repeat switch again.



- When the Disc magazine is eject, Track repeat should be initiated again.

TRACK SCAN

1

Press the Track scan switch.
(This initiates Track scan.)

2

The first 10 seconds of all tracks in the CDs are played in sequence.
(During the track scanning, the Track No. Indicator blinks.)

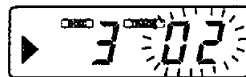

ON

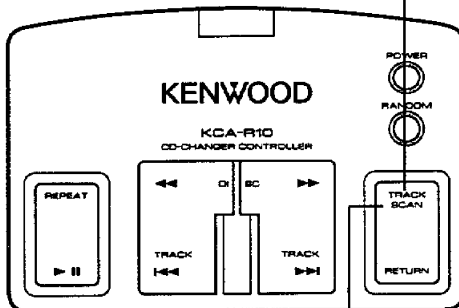

3

When the beginning of a desired track starts to be played, press the Track scan switch.
(Track scan is released and normal CD play starts.)



- Track scan plays the beginnings of all tracks in a disc repeatedly.

RANDOM PLAY

1

Press the Random switch.
(RDM indicator is turned on, the Track No. indication changes one after another and selects the Track from the disc being played.)

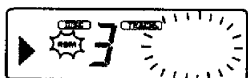

During Random Search

2

The tracks in the CD is played in a random order. When all of the tracks in that CD have been played, the next CD is played in a random order.

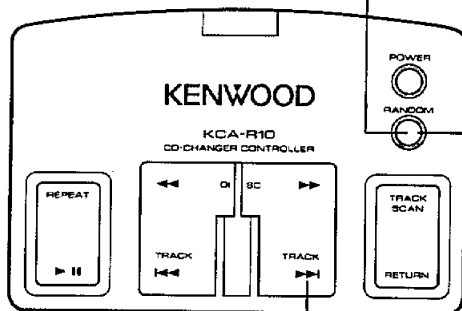

3

If the selected track is not what you wish, press **▶▶|** switch.
(Next selection will take place.)

TO RELEASE

Press the Random switch again.

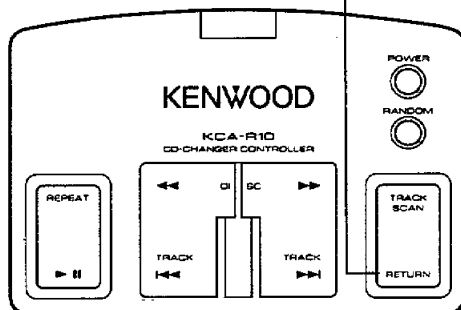

RETURN

If you press the Return switch, the unit returns to the beginning of the disc that you are listening to and starts Replay.

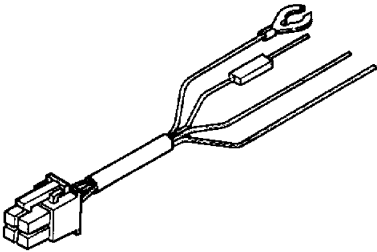

ACCESSORIES AND INSTALLATION

■ ACCESSORIES

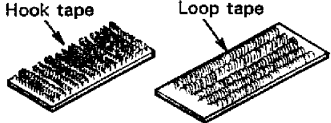
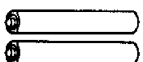
No.	Part name	External view	Number of units
①	Power connection cord		1
②	Metal fixture		2
③	Pan head screws (M3×5)		4
④	Velcro		Units for Each two
⑤	Battery ("AAA" UM-4)		2

■ INSTALLATION

1. Before installation and wiring, remove the ⊖ terminal of the battery to prevent short-circuiting.
2. Connect the input and output cords of the system.
3. Connect the ground to the metal chassis of the car.
4. Connect the back-up power supply lead (yellow).
5. Connect the accessory power lead (red).
6. Install the set and after confirming the installation and wirings are correct, connect the ⊖ terminal of the battery.
7. After installing, surely press the Reset button.



- If a fuse is blown, first check that the associated wires are not short-circuited then replace the fuse with a new one having the same capacity.
- Secure unconnected wires properly so that they do not contact the vehicle chassis.
- Do not remove the caps attached to the unused terminals.

CONNECTION

ENGLISH

KDC-C400/C300 (Option)

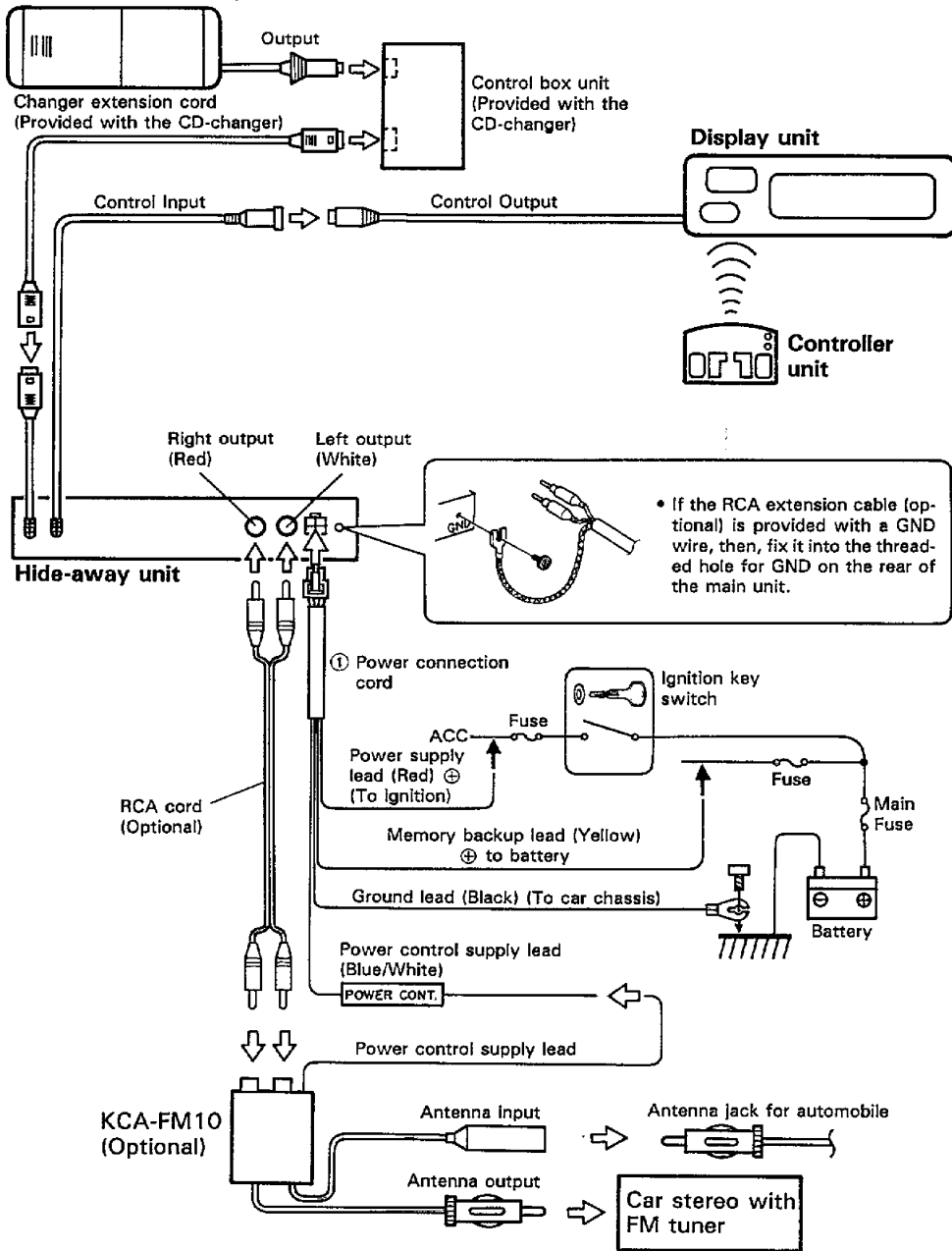

INSTALLATION

■ Installation of Controller unit and Display unit

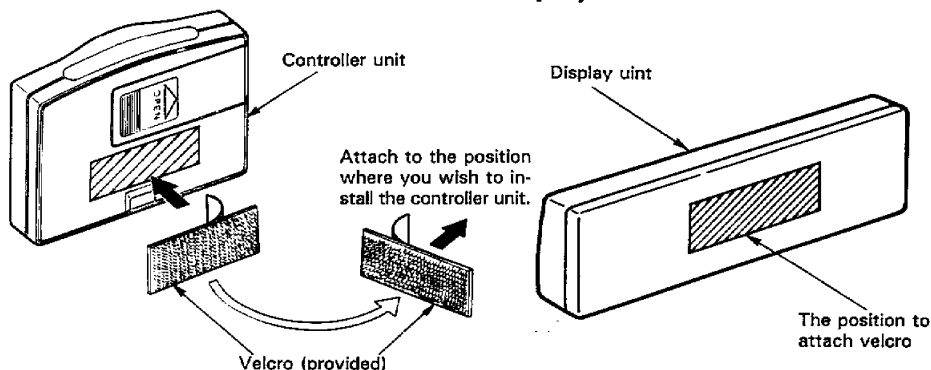

Attach one velcro to the slanted-line of the controller and display units as shown above, and attach the other velcro to the parts where you wish to attach the controller and display units. Then, put the velcros together and install the controller and display units.

CAUTION

- Be sure not to place the unit on such place as where it is exposed to direct sunlight and temperature eventually rises. It results in the deformation of the case, breakage of batteries, leakage of battery liquid and so on.
- Depending on the installing location, the display unit may not be able to receive the signals from the controller unit; Install them after confirming that the signals can be received.
- Install the unit in such a way that it does not disturb driving.

■ Loading/replacing batteries

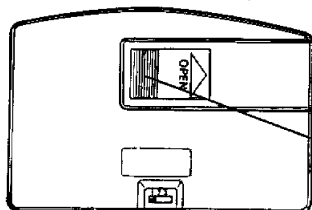

Insert batteries following the illustration inside the battery box, taking care not to reverse the ⊕ and ⊖ polarity.

- The control unit uses two "AAA"-size (UM-4) batteries. The battery life is approximately one year. When the life has expired, please replace both of them with new batteries.

CAUTION

- The provided batteries are not rechargeable. Do not throw batteries in life.

Notes Regarding to the Use of Batteries

If a battery is used improperly, liquid leakage or brokerage of the battery may be brought about. Obey the following actions:

- Put the battery into the battery compartment while keeping its pole correctly.
- If the battery-liquid leakage takes place, wipe the battery liquid left in the compartment well with soft and dry cloth then replace the battery with new one.
- Do not short-circuit the metal built in the battery compartment while a battery is being placed there.
- Do not use different kind of battery and second-hand battery together.
- Do not throw the battery into flame.

INSTALLATION

ENGLISH

■ Installation of Hide-away Unit

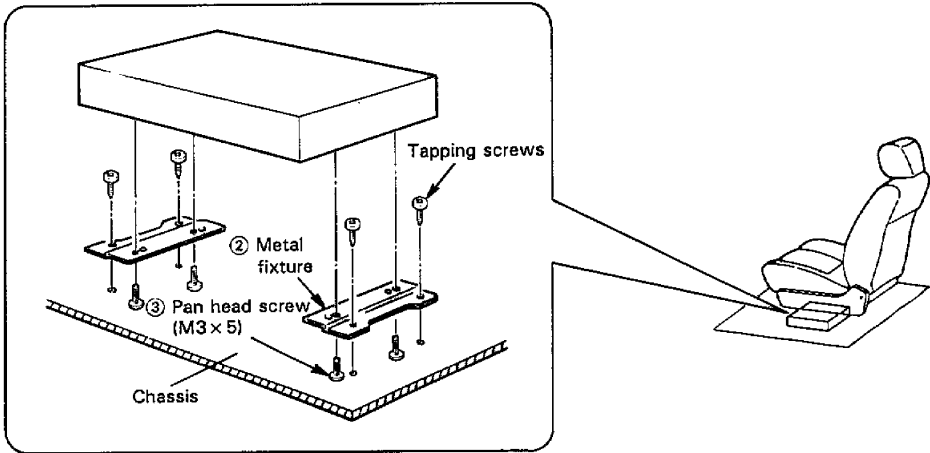

Install the Hide-away Unit beneath the front sheet using ② metal fixture and ③ pan head screw as shown in the above figure.

TROUBLESHOOTING GUIDE

What often appears to be a malfunction is often due to user error in operation or connection. When trouble occurs with your unit, please check the following before calling for service.

Symptom	Cause	Remedy
Power is not turned ON.	<ol style="list-style-type: none">1. Output cable from the controller is not connected.2. Power cord is not connected to the hide-away unit.3. The engine key switch of the car is not set to ACC ON.4. The incorporated microcomputer is not operating correctly due to some effect.5. Fuse is blown.	<ol style="list-style-type: none">1. Connect the controller cable correctly.2. Connect the power cord to the hide-away unit as instructed in the instruction manual.3. Set the engine key switch to ACC ON.4. Press the Reset button of the controller unit.5. Check that the cords are not short-circuited, and then replace the fuse with a specified one.
Operation buttons do not function.	Correct operation is not obtained due to a sudden change in the power voltage, etc.	Press the Reset button.
CD play does not start.	<ol style="list-style-type: none">1. Player is set to the play-pause mode.2. Power switches not turned ON.	<ol style="list-style-type: none">1. Press the ► switch.2. Press the Power switch.
The specified disc is not played and the next disc is played.	<ol style="list-style-type: none">1. The specified disc is too dirty.2. The disc is placed upside down.3. Two discs are set in the same position.4. The specified disc is placed in a position with a different number.5. The disc is damaged or scratched seriously.	<ol style="list-style-type: none">1. Clean the disc.2. Eject the magazine and re-insert the disc correctly.3. Eject the magazine and set each disc correctly.4. Eject the magazine to check the disc number and the position number, then specify again.5. Play other discs.
No sound is output while the changer indicator is shown.	<ol style="list-style-type: none">1. Volume is set to the minimum level.2. The incorporated microcomputer is not operating correctly.3. System connections are made imperfectly (power cord, connection of pre-out jacks, or speaker connections, etc.).	<ol style="list-style-type: none">1. Increase the volume level.2. Press the Reset button of this unit.3. Check the connections according to the instruction manual. If anything is wrong, reconnect it correctly.
Even when the required track is specified, the specified track is not played or the player does not function.	The player is set to random play.	Release random play.

TROUBLESHOOTING GUIDE

Other than the previous, this unit displays various error indications to show the following messages.

E 00: The CD-changer control output is not connected.

E 01: No disc magazine in the changer, or the magazine is not set completely.

E 02: No discs in the disc magazine.

E 04: Disc is too dirty.

Condensation has occurred on the disc, or water drops are on the disc.

Disc is set upside down.

E 99: Operation incorrect due to something being defective.

Press the Reset button on this unit.

If the "E 99" indication does not disappear with this operation, consult your nearest KENWOOD Service Agent.

E 0d: • When the temperature exceeds 60°C, the protection circuit is engaged to stop any operation. At this time, this indication will appear.

• Open a window or turn the air-conditioner ON to lower the temperature. After a while, this indication will go out.

• This indication also appears for several seconds when making connections, or when the Reset button is pressed.

E 0E: This is displayed when the condition of "E 0d" is released.

Load: This indication appears while a disc is being changed inside the changer.

SPECIFICATIONS

Specifications subject to change without notice.

Audio Section

Preout level/load 1 V/10 kΩ

General

Operating Voltage 14.4 V (11 ~ 16 V allowable)

Body side (W x H x D)

Controller 85 x 58 x 15 mm
(3-3/8 x 2-5/16 x 9/16 in.)

Display unit 95 x 35 x 19 mm
(3-3/4 x 1-3/8 x 3/4 in.)

Hide-away unit 150 x 25 x 120 mm
(5-7/8 x 1 x 4-3/4 in.)

Weight

Controller 0.05 kg (0.1 lb)

Display unit 0.1 kg (0.2 lb)

Hide-away unit 0.7 kg (1.5 lb)